

Float unit for USB3-A Test Connector

MA092671

OVERVIEW

MA092671 is a float unit for Bluelec USB3 Type-A test plug.

It compensates the possible misalignments between test system mechanics and DUT socket and enables smoother insertion of the test plug.

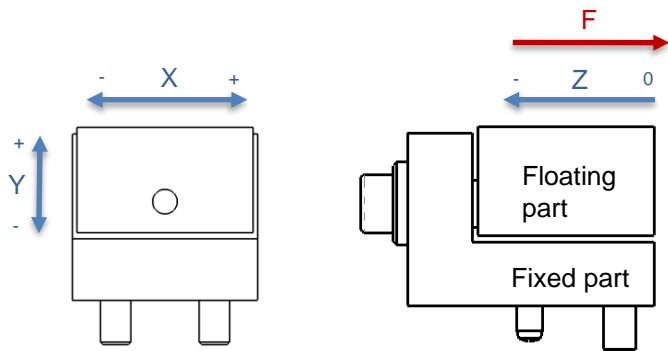

Default position of floating part is '0' for all axes.
Displacement of Z is needed to allow displacement of X and Y.

SPECIFICATIONS

Displacement Zmax	+0.0 / -0,5 mm
Displacement Xmax@Zmax	+/- 0,3 mm
Displacement Ymax@Zmax	+/- 0,3 mm
Spring force F @ Z0	~10N
Spring force F @ Zmax	~14,5N

